

JANOME SEWING CLASS

Party bag with pearl motif

sewing time : 3 hours

Materials (all measurements in cm)

Shell fabric(moire stripe) . . . 28 x 140
 Lining(patterned fabric) . . . 38 x 55
 Batting 28 x 94
 Lace 2 x 100
 Pearl motif 0.4 x 80
 Spring clasp
 Chain (35 cm)



bag size:
37 x 18 x 5cm (miter)

Fabric Preparation

* Shell : moire stripe (dull side is the right side)

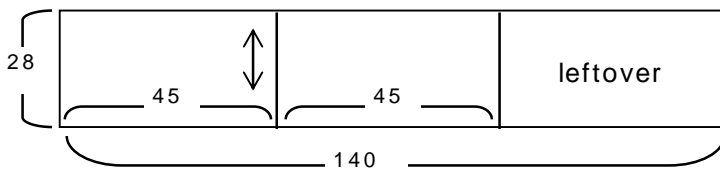

* Lining : cotton fabric (patterned fabric)

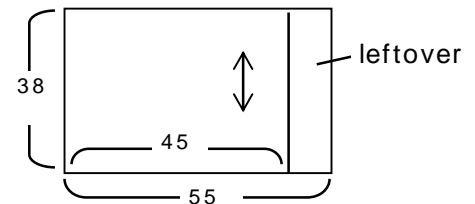

* Batting

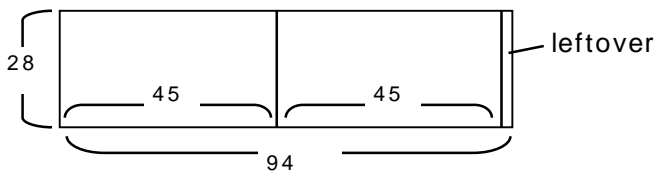

How to make

1. Sew the shell.

Attach batting to the shell piece with an iron and sew the right sides together at the bottom.

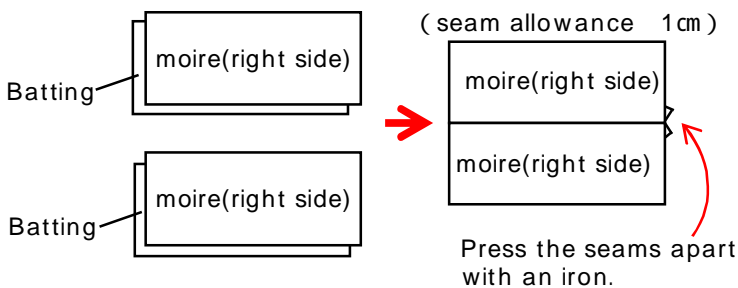

2. Choosing the design layout for the shell.

Decide where you want the pearl motif layout first and then choose your decorative stitches.

Leave a 10cm area around the edge of the fabric to avoid stitching over the miter and top edge.

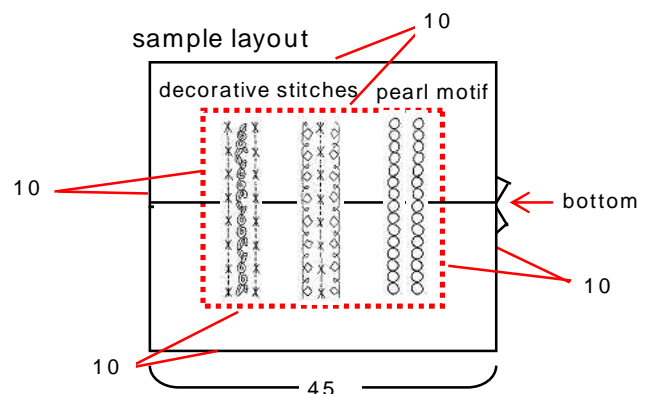

3. Sew the pearl motif onto the fabric.

Using the beading foot(wide broove foot), sew the pearl motif onto the fabric.

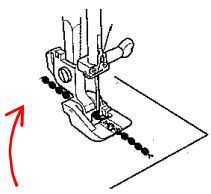

Pull the pearl motif 2cm to the back side of the foot.

zigzag stitch
stitch length...1.5
stitch width...4.0

4. Sew the border design.

Using the border guide foot , sew decorative stitches as you like.

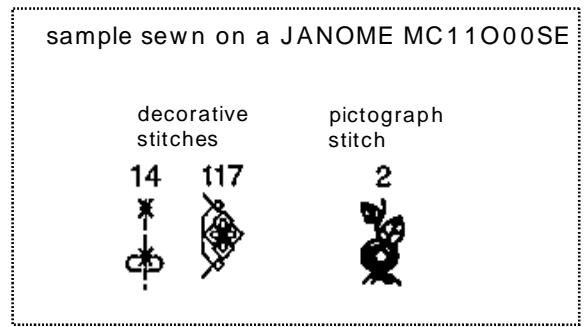

5. Cut the shell.

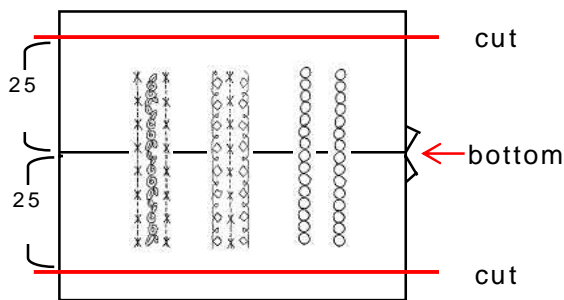

sew the lace edge.
(Lock-a-matic stitch)

6. Sew the lace onto the fabric.

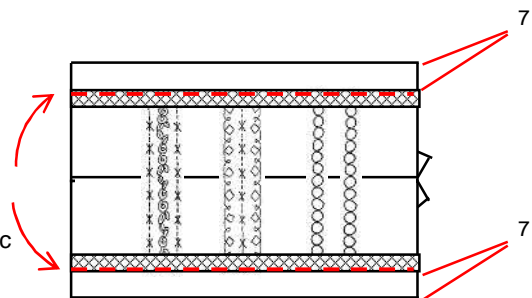

If the pearl motif interferes with sewing, please cut off the excess portion

7. Turn the shell wrong side out. Sew the shell sides together, leaving the top open. Miter the bottom corners of the shell and lining.

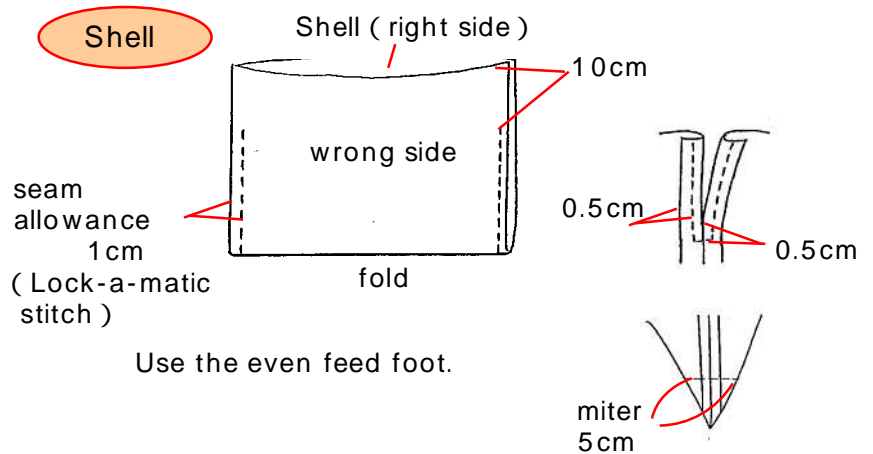
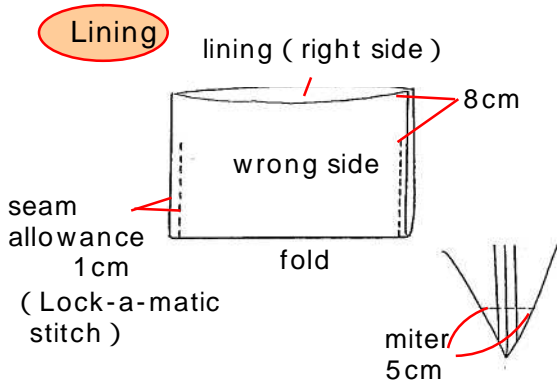

8. Hem the top edge.

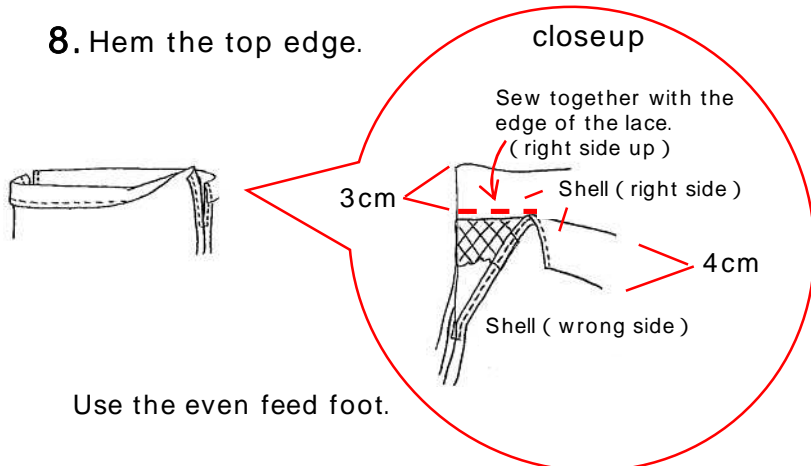

Use the even feed foot.

9. Hand stitch the top parts.

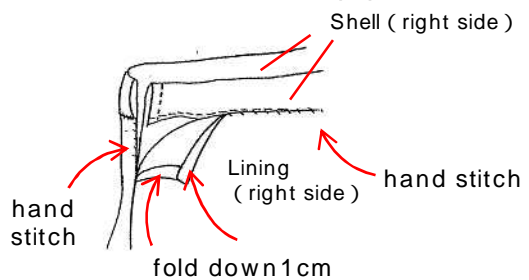

10. Slide the spring clasp into the edge loop.

To keep the clasp from getting caught inside the loop, cover the two clasp ends with the plastic bag before sliding it through.



Cut the plastic bag in half.
(The length of each half should be about 10cm.)



Cover with a piece of the plastic bag.

Cover with a piece of the plastic bag.

Slide the spring clasp into the edge loop, then remove the plastic bag.

Attach the chain to make a handle.
Your party bag is complete!

